

VISOBATH

PROMOBATH 14

NUEVO

MÁS ARTÍCULOS
EXPRESS

ACABADOS
INNOVADORES

DESCUBRE
SU INTERIOR

NOVEDAD

AHORA ACABADOS KYOTO EN
VALENTI - ROBLE COSTA

MUEBLE KYOTO 2 CAJONES

| Acabado | 60cm | 80cm | 100cm |
|-------------|------------|------------|------------|
| Valenti | 74815 | 74817 | 74819 |
| Roble Costa | 74816 | 74818 | 74820 |
| PVP | 300 | 336 | 386 |

COLUMNA

| Acabado | Ref. |
|-------------|------------|
| Valenti | 74821 |
| Roble Costa | 74822 |
| PVP | 240 |



VALENTI



ROBLE COSTA

 Cajones soft close

 Extracción total

 Cajón Textil

 Laminado 3D



KYOTO

MUEBLE + LAVABO FLAT

| Acabado | 60cm | 80cm | 100cm | 120cm 2s |
|-------------|------------|------------|------------|------------|
| Blanco-Ada | 88179 | 88184 | 88189 | 89349 |
| Ceniza | 88180 | 88185 | 88190 | 89350 |
| Cotton | 88183 | 88188 | 88193 | 89353 |
| Avio | 74827 | 74828 | 74829 | 74914 |
| Valenti | 74830 | 74831 | 74832 | 74894 |
| Roble Costa | 74833 | 74834 | 74835 | 74895 |
| PVP | 369 | 419 | 506 | 833 |

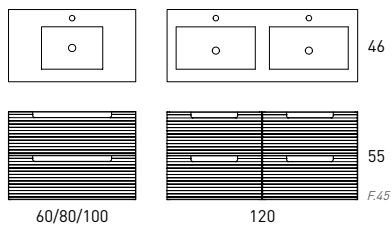

COLUMNA REVERSIBLE

| Acabado | Ref. |
|-------------|------------|
| Blanco-Ada | 88209 |
| Ceniza | 88210 |
| Cotton | 88213 |
| Avio | 70307 |
| Valenti | 74821 |
| Roble Costa | 74822 |
| PVP | 240 |

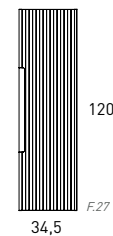

MUEBLE + LAVABO ADA

| Acabado | 60cm | 80cm | 100cm | 120cm 2s |
|-------------|------------|------------|------------|------------|
| Blanco-Ada | 88194 | 88199 | 88204 | 8934901 |
| Ceniza | 88195 | 88200 | 88205 | 8935001 |
| Cotton | 88198 | 88203 | 88208 | 8935301 |
| Avio | 74836 | 74837 | 74838 | 74915 |
| Valenti | 74839 | 74840 | 74841 | 74896 |
| Roble Costa | 74842 | 74843 | 74844 | 74897 |
| PVP | 378 | 432 | 527 | 852 |

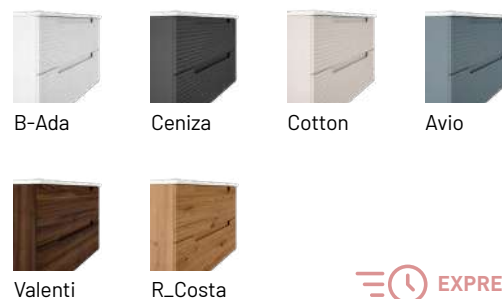
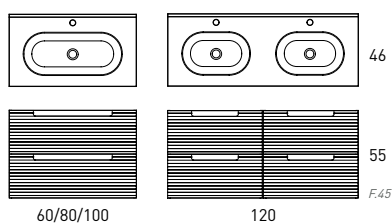

432€

MUEBLE 80 + LAVABO ADA



527€

MUEBLE 100 + LAVABO ADA

Espejo Led LUNE

Ref. 71971

P. 203

MUEBLE 120 + LAVABO FLAT

833€

KYOTO

MUEBLE + LAVABO FLAT

| Acabado | 60cm | 80cm | 100cm | 120cm 2s |
|-------------|------------|------------|------------|------------|
| Blanco-Ada | 88179 | 88184 | 88189 | 89349 |
| Ceniza | 88180 | 88185 | 88190 | 89350 |
| Cotton | 88183 | 88188 | 88193 | 89353 |
| Avio | 74827 | 74828 | 74829 | 74914 |
| Valenti | 74830 | 74831 | 74832 | 74894 |
| Roble Costa | 74833 | 74834 | 74835 | 74895 |
| PVP | 369 | 419 | 506 | 833 |

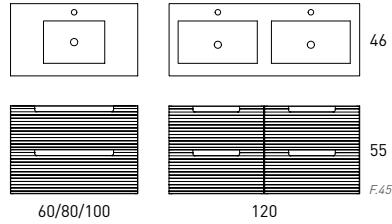

COLUMNA REVERSIBLE

| Acabado | Ref. |
|-------------|------------|
| Blanco-Ada | 88209 |
| Ceniza | 88210 |
| Cotton | 88213 |
| Avio | 70307 |
| Valenti | 74821 |
| Roble Costa | 74822 |
| PVP | 240 |

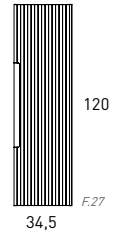

MUEBLE + LAVABO ADA

| Acabado | 60cm | 80cm | 100cm | 120cm 2s |
|-------------|------------|------------|------------|------------|
| Blanco-Ada | 88194 | 88199 | 88204 | 8934901 |
| Ceniza | 88195 | 88200 | 88205 | 8935001 |
| Cotton | 88198 | 88203 | 88208 | 8935301 |
| Avio | 74836 | 74837 | 74838 | 74915 |
| Valenti | 74839 | 74840 | 74841 | 74896 |
| Roble Costa | 74842 | 74843 | 74844 | 74897 |
| PVP | 378 | 432 | 527 | 852 |

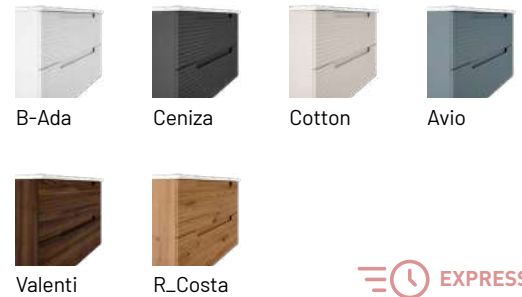
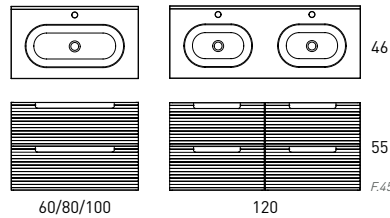

Espejo VARIO 60

Ref. 73494
P. 235



MUEBLE 60 + LAVABO FLAT

369€

Espejo VARIO 60

Ref. 73492
P. 222

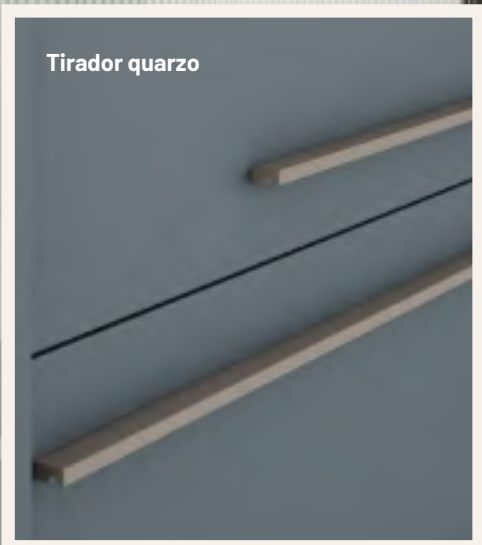
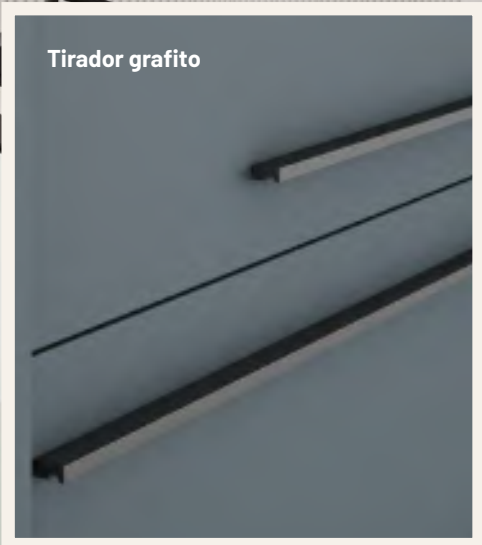

Armario Espejo Miranda 60

Ref. 71975
P. 211



MUEBLE 60 + LAVABO FLAT
309€



AQUA

MUEBLE 2C + LAVABO FLAT

| Acabado | 60cm | | | 80cm | | | 100cm | | |
|------------|--------------|-------------|------------|--------------|-------------|------------|--------------|-------------|------------|
| | Tir. Grafito | Tir. Cuarzo | Tir. Alum. | Tir. Grafito | Tir. Cuarzo | Tir. Alum. | Tir. Grafito | Tir. Cuarzo | Tir. Alum. |
| Aliso | 72092 | 72110 | 73875 | 72098 | 72116 | 73881 | 72104 | 72122 | 73887 |
| Valenti | 72093 | 72111 | 73876 | 72099 | 72117 | 73882 | 72105 | 72123 | 73888 |
| B-ada | 72094 | 72112 | 73877 | 72100 | 72118 | 73883 | 72106 | 72124 | 73889 |
| Ceniza | 72095 | 72113 | 73878 | 72101 | 72119 | 73884 | 72107 | 72125 | 73890 |
| Avio | 72096 | 72114 | 73879 | 72102 | 72120 | 73885 | 72108 | 72126 | 73891 |
| Quarzo | 72097 | 72115 | 73880 | 72103 | 72121 | 73886 | 72109 | 72127 | 73892 |
| PVP | 309 | | | 349 | | | 408 | | |

COLUMNA REVERSIBLE

| Acabado | 120cm | | |
|------------|--------------|-------------|------------|
| | Tir. Grafito | Tir. Cuarzo | Tir. Alum. |
| Aliso | 72062 | 72086 | 73505 |
| Valenti | 72063 | 72087 | 73506 |
| B-ada | 72064 | 72088 | 73496 |
| Ceniza | 72065 | 72089 | 73497 |
| Avio | 72066 | 72090 | 73498 |
| Quarzo | 72067 | 72091 | 73499 |
| PVP | 195 | | |

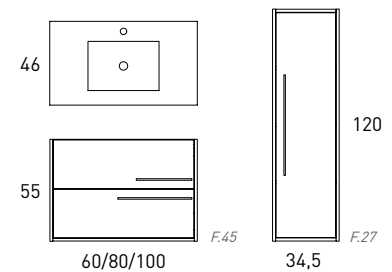

MUEBLE 80 + LAVABO FLAT

349€

MUEBLE 60 SUELO + LAV. MIDI

390€



MIDI

MUEBLE 2C SUSPENDIDO + LAVABO MIDI

| Acabado | Tirador negro | | Tirador cromo | |
|------------|---------------|------------|---------------|------------|
| | 50cm | 60cm | 50cm | 60cm |
| Aliso | 73898 | 73902 | 73906 | 73910 |
| Valenti | 73899 | 73903 | 73907 | 73911 |
| B-ada | 73900 | 73904 | 73908 | 73912 |
| Ceniza | 73901 | 73905 | 73909 | 73913 |
| PVP | 332 | 351 | 332 | 351 |

MUEBLE A SUELO + LAVABO MIDI

| Acabado | Tirador negro | | Tirador cromo | |
|------------|---------------|------------|---------------|------------|
| | 50 1C 1P | 60 1C 2P | 50 1C 1P | 60 1C 2P |
| Aliso | 73914 | 73918 | 73922 | 73926 |
| Valenti | 73915 | 73919 | 73923 | 73927 |
| B-ada | 73916 | 73920 | 73924 | 73928 |
| Ceniza | 73917 | 73921 | 73925 | 73929 |
| PVP | 353 | 390 | 353 | 390 |

Fondo 35,5cm

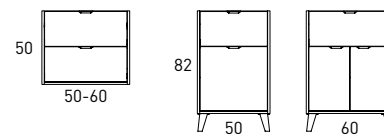

MUEBLE 2C SUSPENDIDO + TAPA

| Acabado | Tirador negro | | Tirador cromo | |
|------------|---------------|------------|---------------|------------|
| | 50cm | 60cm | 50cm | 60cm |
| Aliso | 73930 | 73934 | 73938 | 73942 |
| Valenti | 73931 | 73935 | 73939 | 73943 |
| PVP | 228 | 257 | 228 | 257 |
| B-ada | 73932 | 73936 | 73940 | 73944 |
| Ceniza | 73933 | 73937 | 73941 | 73945 |
| PVP | 267 | 296 | 267 | 296 |

MUEBLE A SUELO + TAPA

| Acabado | Tirador negro | | Tirador cromo | |
|------------|---------------|------------|---------------|------------|
| | 50 1C 1P | 60 1C 2P | 50 1C 1P | 60 1C 2P |
| Aliso | 73946 | 73950 | 73954 | 73958 |
| Valenti | 73947 | 73951 | 73955 | 73959 |
| PVP | 250 | 296 | 250 | 296 |
| B-ada | 73948 | 73952 | 73956 | 73960 |
| Ceniza | 73949 | 73953 | 73957 | 73961 |
| PVP | 288 | 334 | 288 | 334 |

LAVABO PETIT

Lavabo cerámico

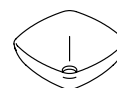

Petit 30x30 cm
Ref. 73467
P. 97



Petit round 32Ø cm
Ref. 73468
P. 107

*Tapa Aliso y Valenti modelo Idole / Tapa B-ada y Ceniza modelo Compatech.



Cierre soft close

Extracción total

Lacado Mate

Acabado laminado

Cajón Textil



348€

MUEBLE 80 TIR.NEGRO + LAVABO FLAT

GRANADA

MUEBLE 2C + LAVABO FLAT

| | 60cm | | | 80cm | | | 100cm | | | 120cm 2 senos | | |
|------------|------------|------------|-----------|------------|------------|-----------|------------|------------|-----------|---------------|------------|-----------|
| | Tir. Alum. | Tir. Negro | Tir. Bco. | Tir. Alum. | Tir. Negro | Tir. Bco. | Tir. Alum. | Tir. Negro | Tir. Bco. | Tir. Alum. | Tir. Negro | Tir. Bco. |
| Crudo | 86685 | 86641 | 86661 | 86693 | 86647 | 86669 | 86701 | 86653 | 86677 | 88146 | 88130 | 88138 |
| Canela | 86686 | 86642 | 86662 | 86694 | 86186 | 86670 | 86702 | 86654 | 86678 | 88147 | 88131 | 88139 |
| Bco-Ada | 86687 | 86643 | 86663 | 86695 | 86185 | 86671 | 86703 | 86655 | 86679 | 88148 | 88132 | 88140 |
| Ceniza | 86688 | 86644 | 86664 | 86696 | 86648 | 86672 | 86704 | 86656 | 86680 | 88149 | 88133 | 88141 |
| PVP | 308 | | | 348 | | | 422 | | | 597 | | |

MUEBLE 2C + LAVABO FLAT + ESPEJO SEVILLA

| | 60cm | | | 80cm | | | 100cm | | | 120cm 2 senos | | |
|------------|------------|------------|-----------|------------|------------|-----------|------------|------------|-----------|---------------|------------|-----------|
| | Tir. Alum. | Tir. Negro | Tir. Bco. | Tir. Alum. | Tir. Negro | Tir. Bco. | Tir. Alum. | Tir. Negro | Tir. Bco. | Tir. Alum. | Tir. Negro | Tir. Bco. |
| Crudo | 86681 | 86637 | 86657 | 86689 | 86645 | 86665 | 86697 | 86649 | 86673 | 88142 | 88126 | 88134 |
| Canela | 86682 | 86638 | 86658 | 86690 | 86187 | 86666 | 86698 | 86650 | 86674 | 88143 | 88127 | 88135 |
| Bco-Ada | 86683 | 86639 | 86659 | 86691 | 86184 | 86667 | 86699 | 86651 | 86675 | 88144 | 88128 | 88136 |
| Ceniza | 86684 | 86640 | 86660 | 86692 | 86646 | 86668 | 86700 | 86652 | 86676 | 88145 | 88129 | 88137 |
| PVP | 343 | | | 391 | | | 470 | | | 656 | | |



Crudo Canela B-ada Ceniza

COLUMNA REVERSIBLE

| | Tirador | | |
|------------|------------|-------|--------|
| | Aluminio | Negro | Blanco |
| Crudo | 86786 | 86794 | 86790 |
| Canela | 86787 | 86190 | 86791 |
| Bco-Ada | 86788 | 86191 | 86792 |
| Ceniza | 86785 | 86793 | 86789 |
| PVP | 189 | | |

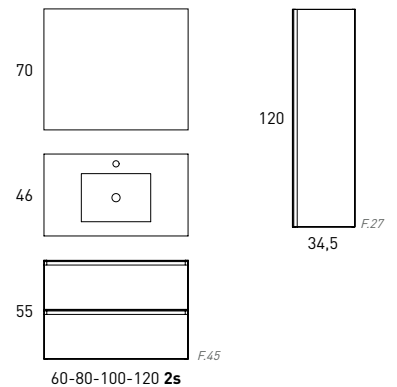

GRANADA

MUEBLE 2C SUELO + LAVABO FLAT

| | 60cm | | | 80cm | | | 100cm | | |
|------------|------------|------------|-----------|------------|------------|-----------|------------|------------|-----------|
| | Tir. Alum. | Tir. Negro | Tir. Bco. | Tir. Alum. | Tir. Negro | Tir. Bco. | Tir. Alum. | Tir. Negro | Tir. Bco. |
| Crudo | 86757 | 86709 | 86733 | 86765 | 86717 | 86741 | 86773 | 86725 | 86749 |
| Canela | 86758 | 86710 | 86734 | 86766 | 86718 | 86742 | 86774 | 86726 | 86750 |
| Bco-Ada | 86759 | 86711 | 86735 | 86767 | 86719 | 86743 | 86775 | 86727 | 86751 |
| Ceniza | 86760 | 86712 | 86736 | 86768 | 86720 | 86744 | 86776 | 86728 | 86752 |
| PVP | 336 | | | 374 | | | 450 | | |

MUEBLE 2C SUELO + LAVABO FLAT + ESPEJO SEVILLA

| | 60cm | | | 80cm | | | 100cm | | |
|------------|------------|------------|-----------|------------|------------|-----------|------------|------------|-----------|
| | Tir. Alum. | Tir. Negro | Tir. Bco. | Tir. Alum. | Tir. Negro | Tir. Bco. | Tir. Alum. | Tir. Negro | Tir. Bco. |
| Crudo | 86753 | 86705 | 86729 | 86761 | 86713 | 86737 | 86769 | 86721 | 86745 |
| Canela | 86754 | 86706 | 86730 | 86762 | 86714 | 86738 | 86770 | 86722 | 86746 |
| Bco-Ada | 86755 | 86707 | 86731 | 86763 | 86715 | 86739 | 86771 | 86723 | 86747 |
| Ceniza | 86756 | 86708 | 86732 | 86764 | 86716 | 86740 | 86772 | 86724 | 86748 |
| PVP | 372 | | | 417 | | | 499 | | |



COLUMNA REVERSIBLE

| | Tirador | | |
|------------|------------|-------|--------|
| | Aluminio | Negro | Blanco |
| Crudo | 86786 | 86794 | 86790 |
| Canela | 86787 | 86190 | 86791 |
| Bco-Ada | 86788 | 86191 | 86792 |
| Ceniza | 86785 | 86793 | 86789 |
| PVP | 189 | | |

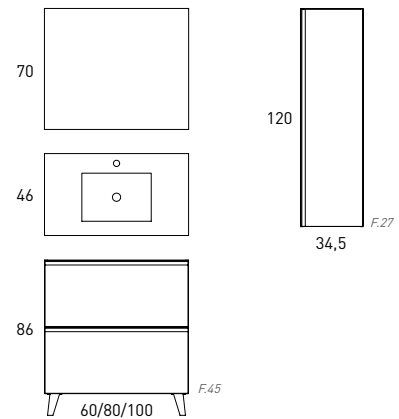





374€

MUEBLE 80 + LAVABO FLAT

 Cajones soft close

 Extracción total

 Acabado laminado

 Lacado Mate

 Cajón Textil

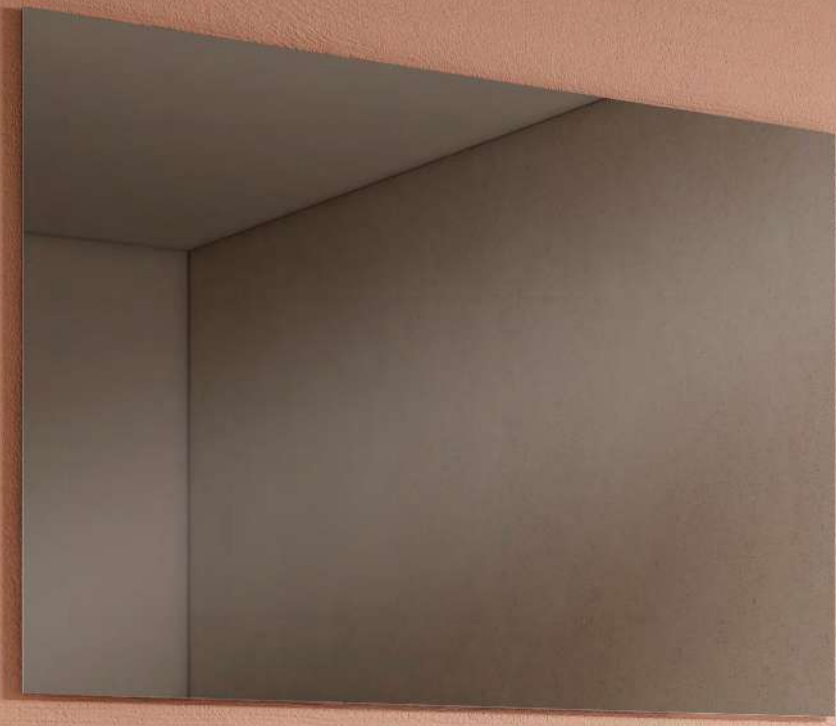

MUEBLE 100 + LAVABO FLAT
507€

■ ■ ■ Cajones soft close

▬ ▬ ▬ Extracción total

— Acabado laminado

▭ Lacado Mate

▬ ▬ ▬ Cajón Textil

GRANADA

MUEBLE 3C + LAVABO FLAT

| | 60cm | | | 80cm | | | 100cm | | |
|------------|------------|------------|-----------|------------|------------|-----------|------------|------------|-----------|
| | Tir. Alum. | Tir. Negro | Tir. Bco. | Tir. Alum. | Tir. Negro | Tir. Bco. | Tir. Alum. | Tir. Negro | Tir. Bco. |
| Crudo | 70554 | 70566 | 70578 | 70558 | 70570 | 70582 | 70562 | 70574 | 70586 |
| Canela | 70555 | 70567 | 70579 | 70559 | 70571 | 70583 | 70563 | 70575 | 70587 |
| Bco-Ada | 70556 | 70568 | 70580 | 70560 | 70572 | 70584 | 70564 | 70576 | 70588 |
| Ceniza | 70557 | 70569 | 70581 | 70561 | 70573 | 70585 | 70565 | 70577 | 70589 |
| PVP | 379 | | | 434 | | | 507 | | |

MUEBLE 3C + LAVABO FLAT + ESPEJO SEVILLA

| | 60cm | | | 80cm | | | 100cm | | |
|------------|------------|------------|-----------|------------|------------|-----------|------------|------------|-----------|
| | Tir. Alum. | Tir. Negro | Tir. Bco. | Tir. Alum. | Tir. Negro | Tir. Bco. | Tir. Alum. | Tir. Negro | Tir. Bco. |
| Crudo | 70590 | 70602 | 70614 | 70594 | 70606 | 70618 | 70598 | 70610 | 70622 |
| Canela | 70591 | 70603 | 70615 | 70595 | 70607 | 70619 | 70599 | 70611 | 70623 |
| Bco-Ada | 70592 | 70604 | 70616 | 70596 | 70608 | 70620 | 70600 | 70612 | 70624 |
| Ceniza | 70593 | 70605 | 70617 | 70597 | 70609 | 70621 | 70601 | 70613 | 70625 |
| PVP | 415 | | | 477 | | | 555 | | |

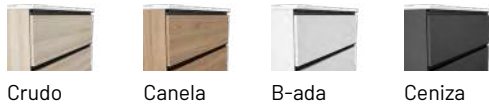

COLUMNA REVERSIBLE

| | Tirador | | |
|------------|------------|-------|--------|
| | Aluminio | Negro | Blanco |
| Crudo | 86786 | 86794 | 86790 |
| Canela | 86787 | 86190 | 86791 |
| Bco-Ada | 86788 | 86191 | 86792 |
| Ceniza | 86785 | 86793 | 86789 |
| PVP | 189 | | |

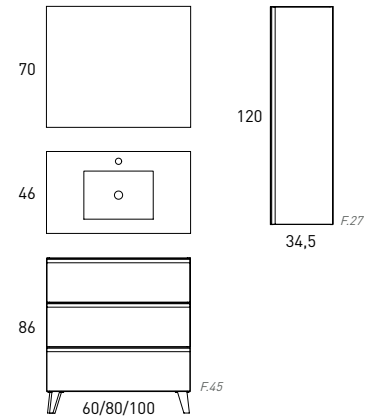

434€

MUEBLE 80 + LAVABO FLAT

ELEVEN

MUEBLE 1 CAJON + LAVABO FLAT

| Acabado | 60cm | 80cm | 100cm | 120cm 2s |
|------------|------------|------------|------------|------------|
| Blanco-Ada | 71314 | 71319 | 71324 | 71329 |
| Ceniza | 71315 | 71320 | 71325 | 71330 |
| Avio | 71316 | 71321 | 71326 | 71331 |
| Valenti | 71317 | 71322 | 71327 | 71332 |
| Crudo | 71318 | 71323 | 71328 | 71333 |
| PVP | 231 | 247 | 309 | 553 |

COLUMNA Reversible

| Acabado | Ref. |
|------------|------------|
| Blanco-Ada | 85656 |
| Ceniza | 85657 |
| Avio | 85658 |
| Valenti | 85659 |
| Crudo | 85660 |
| PVP | 292 |

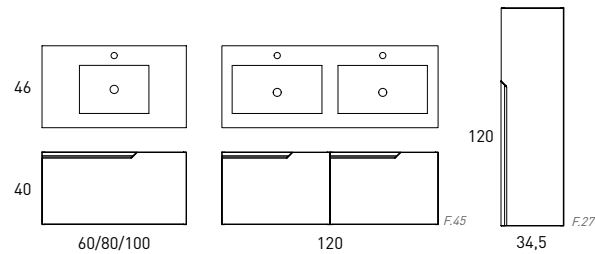

247€
MUEBLE 80 + LAVABO FLAT

ELEVEN

MUEBLE 1 CAJON + LAVABO FLAT

| Acabado | 60cm | 80cm | 100cm | 120cm 2s |
|------------|------------|------------|------------|------------|
| Blanco-Ada | 85616 | 85621 | 85626 | 85631 |
| Ceniza | 85617 | 85622 | 85627 | 85632 |
| Avio | 85618 | 85623 | 85628 | 85633 |
| Valenti | 85619 | 85624 | 85629 | 85634 |
| Crudo | 85620 | 85625 | 85630 | 85635 |
| PVP | 250 | 275 | 342 | 581 |

COLUMNA Reversible

| Acabado | Ref. |
|------------|------------|
| Blanco-Ada | 85656 |
| Ceniza | 85657 |
| Avio | 85658 |
| Valenti | 85659 |
| Crudo | 85660 |
| PVP | 292 |

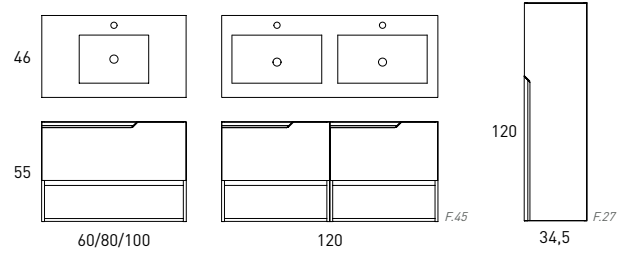

BOX

MUEBLE 2P + LAVABO FLAT

| Acabado | 60cm | 80cm |
|--------------|------------|------------|
| Nieve Brillo | 83363 | 83367 |
| Gris Brillo | 83364 | 83368 |
| Abedul | 84945 | 84949 |
| Crudo | 84944 | 84948 |
| Valenti | 89307 | 89308 |
| PVP | 215 | 227 |

MB 2P + LAV FLAT + ESP SEVILLA

| Acabado | 60cm | 80cm |
|--------------|------------|------------|
| Nieve Brillo | 82950 | 82955 |
| Gris Brillo | 82951 | 82956 |
| Abedul | 84943 | 84947 |
| Crudo | 84942 | 84946 |
| Valenti | 89309 | 89310 |
| PVP | 251 | 270 |

AUXILIAR

| Acabado | Columna | Colgar |
|--------------|------------|------------|
| Nieve Brillo | 82323 | 82328 |
| Gris Brillo | 82325 | 82330 |
| Abedul | 84488 | 84492 |
| Crudo | 84487 | 84491 |
| Valenti | 88374 | 88375 |
| PVP | 188 | 125 |

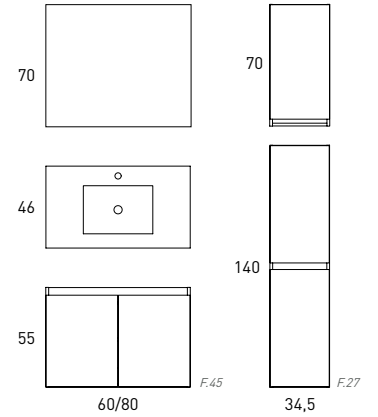

Nieve Br.



Gris Br.



Abedul



Crudo



Valenti



MUEBLE 60 + LAVABO FLAT

215€

BOX

MUEBLE 2CAJ/1PTA + LAVABO FLAT

| Acabado | 80 izq. | 80 der. | 90 izq. | 90 der. | 100 izq. | 100 der. |
|--------------|------------|------------|------------|------------|------------|------------|
| Nieve Brillo | 86796 | 86800 | 83427 | 83419 | 86804 | 86808 |
| Gris Brillo | 86795 | 86799 | 83428 | 83420 | 86803 | 86807 |
| Abedul | 86797 | 86801 | 84985 | 84981 | 86805 | 86809 |
| Crudo | 86798 | 86802 | 84984 | 84980 | 86806 | 86810 |
| Valenti | 89313 | 89314 | 89315 | 89316 | 89317 | 89318 |
| PVP | 363 | 363 | 438 | 438 | 469 | 469 |

MUEBLE 2CAJ/1PTA + LAV FLAT + ESP SEVILLA

| Acabado | 80 izq. | 80 der. | 90 izq. | 90 der. | 100 izq. | 100 der. |
|--------------|------------|------------|------------|------------|------------|------------|
| Nieve Brillo | 86812 | 86816 | 83423 | 83415 | 86820 | 86824 |
| Gris Brillo | 86811 | 86815 | 83424 | 83416 | 86819 | 86823 |
| Abedul | 86813 | 86817 | 84983 | 84979 | 86821 | 86825 |
| Crudo | 86814 | 86818 | 84982 | 84978 | 86822 | 86826 |
| Valenti | 89319 | 89320 | 89321 | 89322 | 89323 | 89324 |
| PVP | 406 | 406 | 485 | 485 | 518 | 518 |

*Izquierda / Derecha hace referencia a la poza del lavabo.

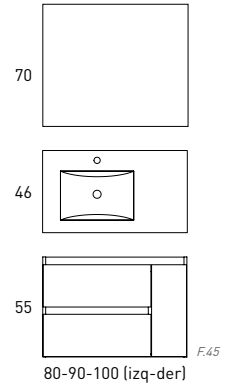

BOX



MUEBLE 2C + LAVABO FLAT - Fondo 45

| Acabado | 60cm | 70cm | 80cm | 100cm | 120cm 2S |
|--------------|------------|------------|------------|------------|------------|
| Nieve Brillo | 83375 | 83383 | 83387 | 83391 | 85279 |
| Gris Brillo | 83376 | 83384 | 83388 | 83392 | 85280 |
| Abedul | 84953 | 84957 | 84961 | 84965 | 84977 |
| Crudo | 84952 | 84956 | 84960 | 84964 | 84976 |
| Valenti | 88359 | 88360 | 88361 | 88362 | 88363 |
| PVP | 276 | 302 | 309 | 373 | 557 |

Fondo Reducido 40

| 60 red. | 80 red. |
|------------|------------|
| 83399 | 83407 |
| 83400 | 83408 |
| 84969 | 84973 |
| 84968 | 84972 |
| 89333 | 89334 |
| 276 | 309 |

AUXILIAR

| Acabado | Columna | Colgar |
|--------------|------------|------------|
| Nieve Brillo | 82323 | 82328 |
| Gris Brillo | 82325 | 82330 |
| Abedul | 84488 | 84492 |
| Crudo | 84487 | 84491 |
| Valenti | 88374 | 88375 |
| PVP | 188 | 125 |

MUEBLE 2C + LAV FLAT + ESP SEVILLA - Fondo 45

| Acabado | 60cm | 70cm | 80cm | 100cm | 120cm 2S |
|--------------|------------|------------|------------|------------|------------|
| Nieve Brillo | 82883 | 83379 | 82886 | 82889 | 85277 |
| Gris Brillo | 82884 | 83380 | 82887 | 82890 | 85278 |
| Abedul | 84951 | 84955 | 84959 | 84963 | 84975 |
| Crudo | 84950 | 84954 | 84958 | 84962 | 84974 |
| Valenti | 88364 | 88365 | 88366 | 88367 | 88368 |
| PVP | 312 | 341 | 351 | 421 | 615 |

Fondo Reducido 40

| 60 red. | 80 red. |
|------------|------------|
| 83395 | 83403 |
| 83396 | 83404 |
| 84967 | 84971 |
| 84966 | 84970 |
| 89335 | 89336 |
| 312 | 351 |

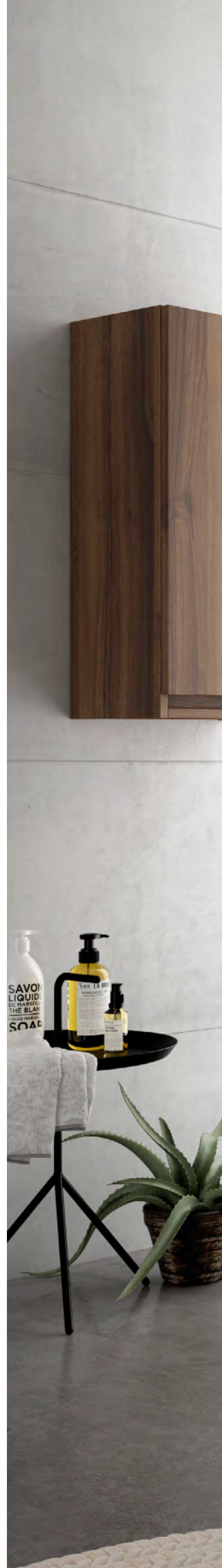
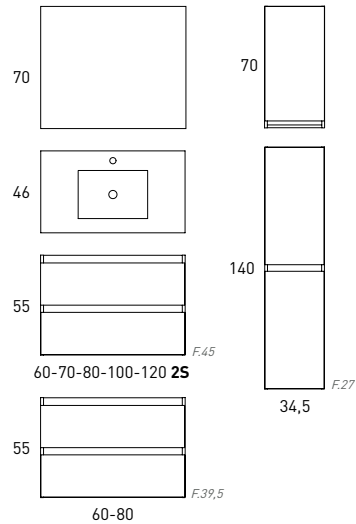

MUEBLE 80 + LAVABO FLAT

309€



BOX



MUEBLE 2C SUELO + LAVABO FLAT

| Acabado | 80cm |
|--------------|------------|
| Nieve Brillo | 83862 |
| Crudo | 85023 |
| Valenti | 89311 |
| PVP | 329 |



Nieve Br.

Crudo

Valenti

MB 2C SUELO + LAV FLAT + ESP SEVILLA

| Acabado | 80cm |
|--------------|------------|
| Nieve Brillo | 83860 |
| Crudo | 85022 |
| Valenti | 89312 |
| PVP | 368 |

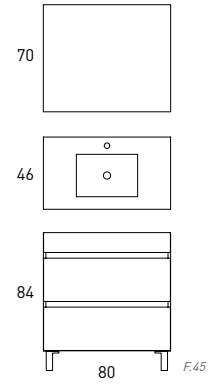

329€
MUEBLE 80 + LAVABO FLAT

BOX



MUEBLE 3C + LAVABO FLAT - Fondo 45

| Acabado | 60cm | 80cm | 100cm | 120cm 2S |
|--------------|------------|------------|------------|------------|
| Nieve Brillo | 83327 | 83331 | 83335 | 83359 |
| Gris Brillo | 83328 | 83332 | 83336 | 83360 |
| Abedul | 84921 | 84925 | 84929 | 84941 |
| Crudo | 84920 | 84924 | 84928 | 84940 |
| Valenti | 89325 | 89326 | 89327 | 89328 |
| PVP | 343 | 389 | 461 | 801 |

Fondo Reducido 40

| 60 red. | 80 red. |
|------------|------------|
| 83343 | 83351 |
| 83344 | 83352 |
| 84933 | 84937 |
| 84932 | 84936 |
| 89337 | 89338 |
| 343 | 389 |

AUXILIAR

| Acabado | Columna | Colgar |
|--------------|------------|------------|
| Nieve Brillo | 82323 | 82328 |
| Gris Brillo | 82325 | 82330 |
| Abedul | 84488 | 84492 |
| Crudo | 84487 | 84491 |
| Valenti | 88374 | 88375 |
| PVP | 188 | 125 |

MUEBLE 3C+ LAV FLAT + ESP SEVILLA - Fondo 45

| Acabado | 60cm | 80cm | 100cm | 120cm 2S |
|--------------|------------|------------|------------|------------|
| Nieve Brillo | 82895 | 82898 | 82901 | 83355 |
| Gris Brillo | 82896 | 82899 | 82902 | 83356 |
| Abedul | 84919 | 84923 | 84927 | 84939 |
| Crudo | 84918 | 84922 | 84926 | 84938 |
| Valenti | 89329 | 89330 | 89331 | 89332 |
| PVP | 379 | 432 | 509 | 860 |

Fondo Reducido 40

| 60 red. | 80 red. |
|------------|------------|
| 83339 | 83347 |
| 83340 | 83348 |
| 84931 | 84935 |
| 84930 | 84934 |
| 89339 | 89340 |
| 379 | 432 |

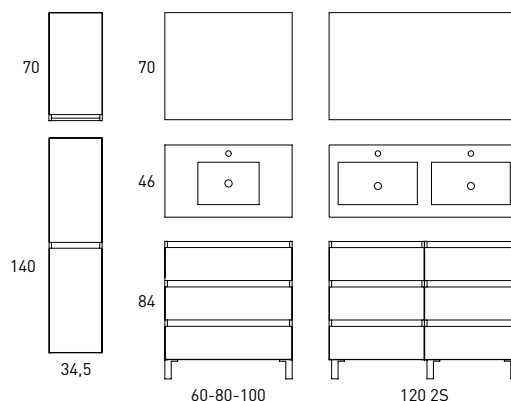

389€

MUEBLE 80 + LAVABO FLAT

A close-up photograph of several green leaves covered in water droplets, creating a fresh and natural aesthetic. The leaves are layered, with some in sharp focus and others blurred in the background. The lighting is soft, highlighting the texture of the leaves and the glistening water droplets.

PROMO BATH 14





MUEBLE 80 + LAVABO ADA

442€

ARCO

MUEBLE + LAVABO FLAT

| Acabado | 60cm | 80cm | 100cm | 120cm 2s |
|------------|------------|------------|------------|------------|
| Blanco-Ada | 86196 | 86204 | 86212 | 88157 |
| Ceniza | 86197 | 86205 | 86213 | 88158 |
| Musgo | 88150 | 88152 | 88154 | 88156 |
| Avio | 86594 | 86595 | 86596 | 88159 |
| PVP | 399 | 432 | 515 | 698 |

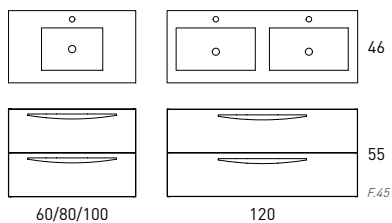

COLUMNA REVERSIBLE

| Acabado | Ref. |
|------------|------------|
| Blanco-Ada | 86119 |
| Ceniza | 86122 |
| Musgo | 86123 |
| Avio | 86120 |
| PVP | 226 |

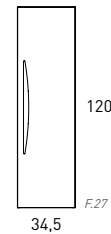

MUEBLE + LAVABO ADA

| Acabado | 60cm | 80cm | 100cm | 120cm 2s |
|------------|------------|------------|------------|------------|
| Blanco-Ada | 86828 | 86831 | 86834 | 88161 |
| Ceniza | 86829 | 86832 | 86835 | 88162 |
| Musgo | 88151 | 88153 | 88155 | 88160 |
| Avio | 86597 | 86598 | 86599 | 88163 |
| PVP | 411 | 442 | 533 | 717 |

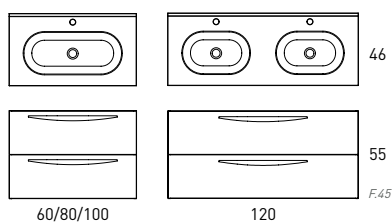

BONDI

MUEBLE + LAVABO FLAT

| | 60cm | | | 80cm | | | 100cm | | | 120cm 2 senos | | |
|------------|------------|------------|-----------|------------|------------|-----------|------------|------------|-----------|---------------|------------|-----------|
| | Tir. Inox | Tir. Negro | Tir. Bco. | Tir. Inox | Tir. Negro | Tir. Bco. | Tir. Inox | Tir. Negro | Tir. Bco. | Tir. Inox | Tir. Negro | Tir. Bco. |
| Valenti | 89200 | 89216 | 89232 | 89204 | 89220 | 89236 | 89208 | 89224 | 89240 | 89212 | 89228 | 89244 |
| Crudo | 89201 | 89217 | 89233 | 89205 | 89221 | 89237 | 89209 | 89225 | 89241 | 89213 | 89229 | 89245 |
| Bco-ada | 89202 | 89218 | 89234 | 89206 | 89222 | 89238 | 89210 | 89226 | 89242 | 89214 | 89230 | 89246 |
| Ceniza | 89203 | 89219 | 89235 | 89207 | 89223 | 89239 | 89211 | 89227 | 89243 | 89215 | 89231 | 89247 |
| PVP | 311 | | | 345 | | | 410 | | | 595 | | |

MUEBLE + LAVABO FLAT + ESPEJO SEVILLA

| | 60cm | | | 80cm | | | 100cm | | | 120cm 2 senos | | |
|------------|------------|------------|-----------|------------|------------|-----------|------------|------------|-----------|---------------|------------|-----------|
| | Tir. Inox | Tir. Negro | Tir. Bco. | Tir. Inox | Tir. Negro | Tir. Bco. | Tir. Inox | Tir. Negro | Tir. Bco. | Tir. Inox | Tir. Negro | Tir. Bco. |
| Valenti | 89248 | 89264 | 89280 | 89252 | 89268 | 89284 | 89256 | 89272 | 89288 | 89260 | 89276 | 89292 |
| Crudo | 89249 | 89265 | 89281 | 89253 | 89269 | 89285 | 89257 | 89273 | 89289 | 89261 | 89277 | 89293 |
| Bco-ada | 89250 | 89266 | 89282 | 89254 | 89270 | 89286 | 89258 | 89274 | 89290 | 89262 | 89278 | 89294 |
| Ceniza | 89251 | 89267 | 89283 | 89255 | 89271 | 89287 | 89259 | 89275 | 89291 | 89263 | 89279 | 89295 |
| PVP | 347 | | | 389 | | | 458 | | | 654 | | |



Valenti



Crudo



B-ada



Ceniza



COLUMNA REVERSIBLE

| | Tirador | | |
|------------|------------|-------|--------|
| | Inox | Negro | Blanco |
| Valenti | 89054 | 88825 | 89047 |
| Crudo | 89052 | 88823 | 89045 |
| Bco-ada | 89048 | 88819 | 89041 |
| Ceniza | 89049 | 88820 | 89042 |
| PVP | 179 | | |

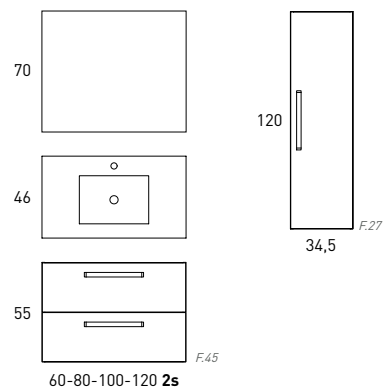

MUEBLE 60 TIR. INOX + LAV. FLAT

311€



MUEBLE 80 + LAVABO FLAT

345€





MUEBLE 80 + LAVABO FLAT
403€

VISION



MUEBLE + LAVABO FLAT

| Acabado | 60cm | 80cm | 100cm | 120cm 2s |
|------------------|------------|--------------|--------------|------------|
| Abedul - Tórtora | 83847 | 83848 | 83849 | 83850 |
| Valenti - Negro | 71295 | 71296 | 71297 | 71298 |
| Nieve Br.- Bco. | 83839 | 83840 | 83841 | 83842 |
| Gris Br.- Bco. | 83855 | 83856 | 83857 | 83858 |
| PVP | 365 | 403 | 482 | 658 |

MUEBLE + LAV FLAT + ESP VISION

| Acabado | 60cm | 80cm | 100cm | 120cm 2s |
|------------------|------------|--------------|--------------|------------|
| Abedul - Tórtora | 83843 | 83844 | 83845 | 83846 |
| Valenti - Negro | 71299 | 71300 | 71301 | 71302 |
| Nieve Br.- Bco. | 83835 | 83836 | 83837 | 83838 |
| Gris Br.- Bco. | 83851 | 83852 | 83853 | 83854 |
| PVP | 428 | 481 | 573 | 763 |

*Espejo VISION / Lavabo FLAT

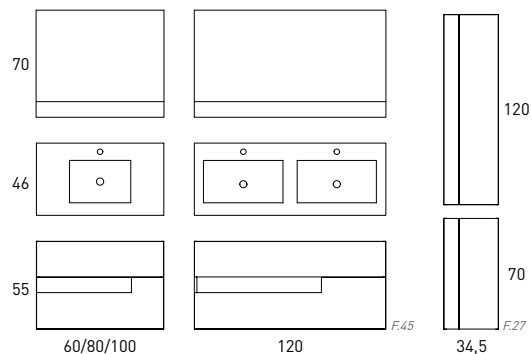

COLUMNA / COLGAR REVERSIBLE

| Acabado | Columna | Colgar |
|------------------|--------------|------------|
| Abedul - Tórtora | 83122 | 83129 |
| Valenti - Negro | 70336 | 70337 |
| Nieve Br.- Bco. | 83119 | 83126 |
| Gris Br.- Bco. | 83125 | 83132 |
| PVP | 202 | 153 |



Abedul
Tórtora



Valenti
Negro



Nieve Br.
Blanco



Gris Br.
Blanco



III Cajones soft close

Extracción total

Acabado laminado

Alto brillo

Cajón Textil

Organizador

Tirador cromado

SCALA

MUEBLE 2C + LAVABO FLAT

| Acabado | 60cm | 80cm | 100cm | 120cm 2s |
|------------|------------|------------|------------|------------|
| B-soul | 86559 | 86563 | 86567 | 86571 |
| Abedul | 86560 | 86564 | 86568 | 86572 |
| Crudo | 86561 | 86565 | 86569 | 86573 |
| Quarzo | 86562 | 86566 | 86570 | 86574 |
| PVP | 337 | 373 | 440 | 599 |

COLUMNA

| Acabado | 1 pta. Izq. | 1 pta. Der. |
|------------|-------------|-------------|
| B-soul | 83906 | 83912 |
| Abedul | 83904 | 83910 |
| Crudo | 83905 | 83911 |
| Quarzo | 83908 | 83914 |
| PVP | 170 | 170 |

MUEBLE + LAV FLAT + ESP SEVILLA

| Acabado | 60cm | 80cm | 100cm | 120cm 2s |
|------------|------------|------------|------------|------------|
| B-soul | 86543 | 86547 | 86551 | 86555 |
| Abedul | 86544 | 86548 | 86552 | 86556 |
| Crudo | 86545 | 86549 | 86553 | 86557 |
| Quarzo | 86546 | 86550 | 86554 | 86558 |
| PVP | 373 | 416 | 488 | 657 |

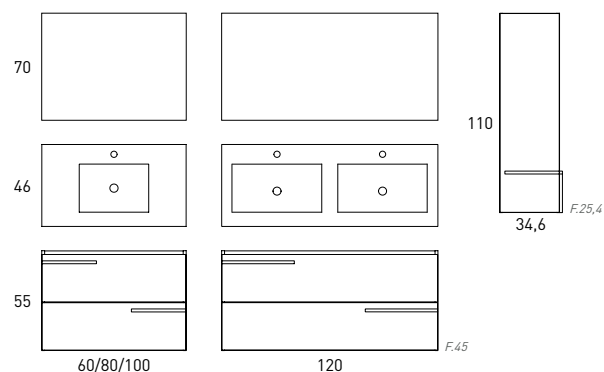

* Espejo SEVILLA / Lavabo FLAT
* Tirador metálico (color grafito)



SCALA

MUEBLE + LAV FLAT + ESTRUCTURA IZ.

| Acabado | 60cm | 80cm | 100cm | 120cm 2s |
|------------|------------|------------|------------|------------|
| B-soul | 84890 | 84898 | 84906 | 84914 |
| Abedul | 84891 | 84899 | 84907 | 84915 |
| Crudo | 84892 | 84900 | 84908 | 84916 |
| Quarzo | 84893 | 84901 | 84909 | 84917 |
| PVP | 434 | 469 | 537 | 695 |

MB + LAV + ESP + ESTANTE + ESTR. IZO.

| Acabado | 60cm | 80cm | 100cm | 120cm 2s |
|------------|------------|------------|------------|------------|
| B-soul | 84886 | 84894 | 84902 | 84910 |
| Abedul | 84887 | 84895 | 84903 | 84911 |
| Crudo | 84888 | 84896 | 84904 | 84912 |
| Quarzo | 84889 | 84897 | 84905 | 84913 |
| PVP | 569 | 621 | 700 | 875 |

COLUMNA

| Acabado | 1 pta. Izq. | 1 pta. Der. |
|------------|-------------|-------------|
| B-soul | 83906 | 83912 |
| Abedul | 83904 | 83910 |
| Crudo | 83905 | 83911 |
| Quarzo | 83908 | 83914 |
| PVP | 170 | 170 |

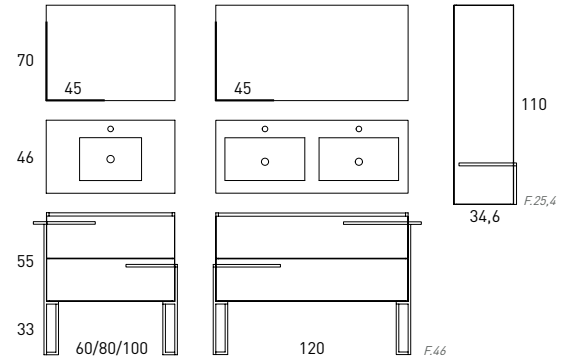

*Espejo ELDA / Lavabo FLAT
*Tirador metálico (color grafito)



469€

**MUEBLE 80 + LAVABO FLAT
+ ESTRUCTURA IZO.**



NOMAD

ENCIMERA NOMAD 10CM

| Acabado | 60cm | 80cm | 100cm | 120cm |
|------------|------------|------------|------------|------------|
| Niágara | 70973 | 70974 | 70975 | 70976 |
| Cala | 70981 | 70982 | 70983 | 70984 |
| Harlem | 70989 | 70990 | 70991 | 70992 |
| PVP | 125 | 137 | 164 | 175 |

*Consultar encimeras a medida.

MUEBLE NOMAD 1C

| Acabado | 60cm | 80cm | 100cm | 120cm |
|------------|------------|------------|------------|------------|
| Niágara | 70977 | 70978 | 70979 | 70980 |
| Cala | 70985 | 70986 | 70987 | 70988 |
| Harlem | 70993 | 70994 | 70995 | 70996 |
| B-ada | 71200 | 71201 | 71202 | 71203 |
| Ceniza | 71017 | 71018 | 71019 | 71020 |
| PVP | 253 | 280 | 322 | 356 |

LAVABOS SOBREPONER

Cerámico



| COLORS | REF. | PVP |
|---------------|-------|------------|
| Blanco brillo | 70310 | 109 |
| Blanco ada | 87434 | 153 |

Solid surface



| ASSEN | QUADRO |
|------------|------------|
| 70311 | 70312 |
| 247 | 270 |
| ARTIC | |
| 70313 | |
| 255 | |

REALIZACIÓN DE TALADROS

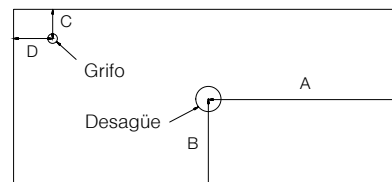

Indique las dimensiones y el diámetro del desagüe y del grifo en milímetros.

La empresa no es responsable de la definición incorrecta de las medidas. No se aceptan devoluciones por este motivo.

PVP 29



Niágara Cala Harlem B-ada Ceniza



Espejo Loira LED

Touch & Antivaho

Ref. 87672
P. 282



Espejo CLOE 60x70cm

Ref. 70082

P. 228

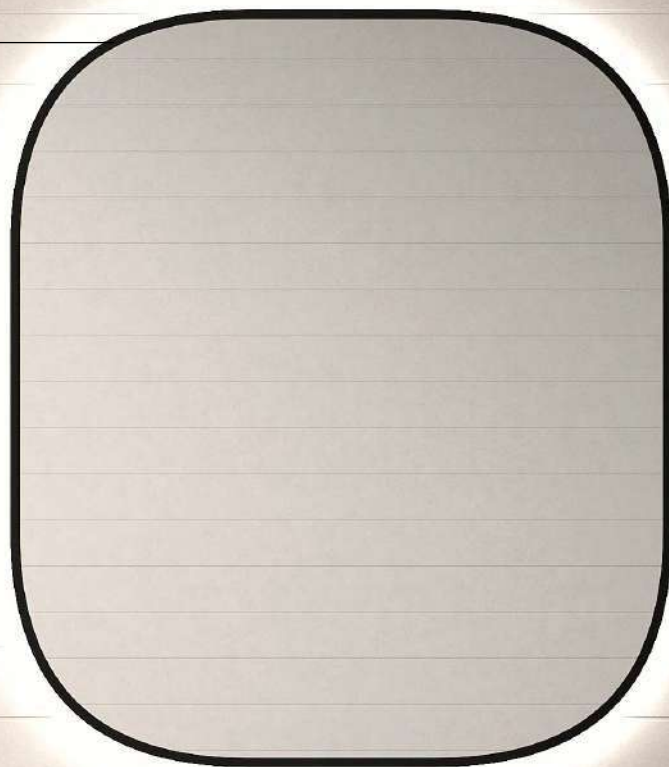

MUEBLE 80 + ENCIMERA 80

417€



[Descubre más posibilidades en nuestro catálogo general](#)

LAGOS 40



MUEBLE 40 + LAVABO + ESPEJO

| | |
|----------------------|-------------|
| Acabado | 40cm |
| Niágara - Tir. Negro | 88104 |
| Aliso - Tir. Negro | 70821 |
| B-ada | 88105 |
| Musgo | 88118 |
| Avio | 88119 |
| Ceniza | 88106 |
| PVP | 219 |

Pack
Mueble, Lavabo y Espejo
Un solo embalaje

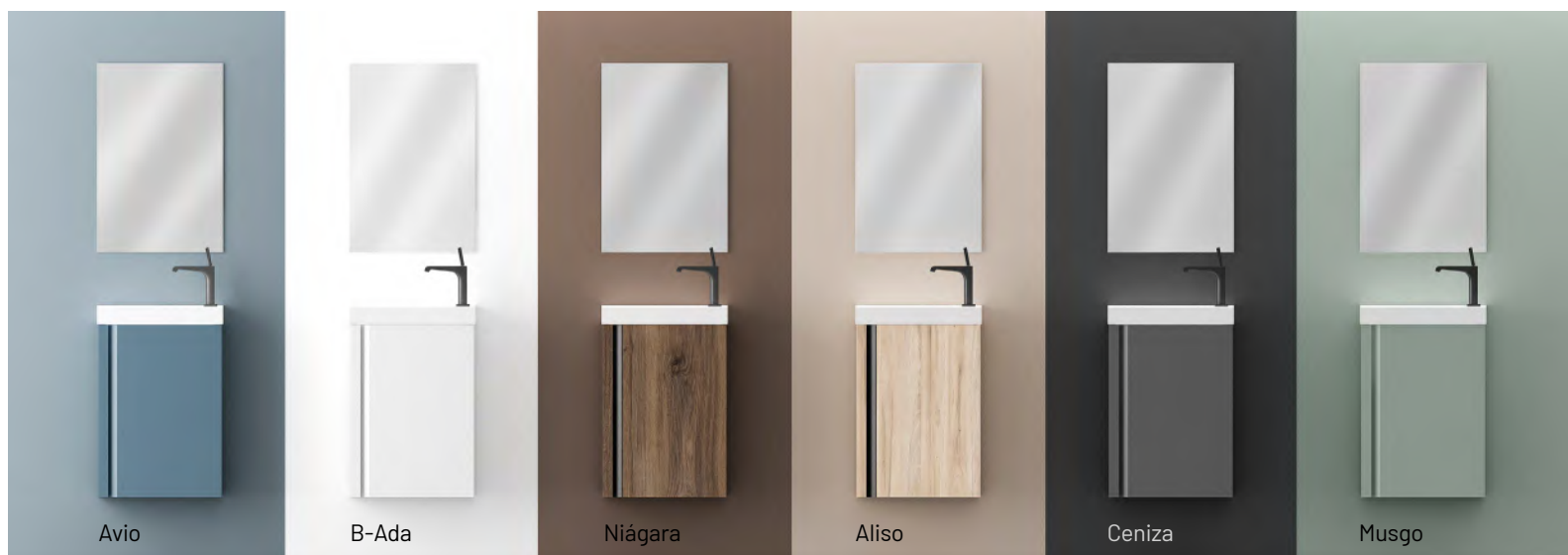
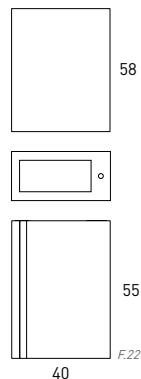
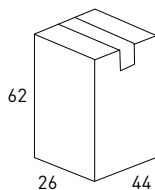

LAGOS 50



MUEBLE 2 PUERTAS + LAVABO

Acabado **50cm**

Aliso - Tir. Negro **72182**

B-ada **72183**

Ceniza **72184**

PVP **199**

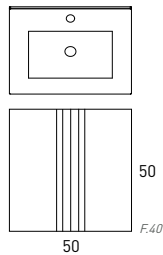

MUEBLE 2 CAJONES + LAVABO

Acabado **50cm**

Aliso - Tir. Negro **72185**

B-ada **72186**

Ceniza **72187**

PVP **269**

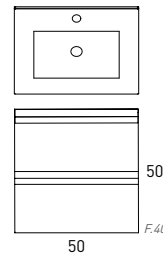

Pack
Mueble + Lavabo
Un solo embalaje

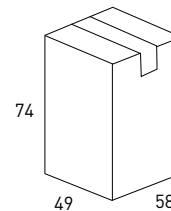

LOFT

Pack
Mueble, Lavabo y Espejo
Un solo embalaje

MUEBLE 40 + LAVABO + ESPEJO

| | |
|----------------|--------------|
| Acabado | 40cm |
| Niágara | 88113 |
| B-ada | 88114 |
| Ceniza | 88115 |
| PVP | 179 |

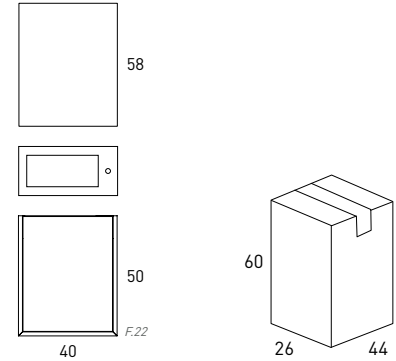

NOVEDAD COLUMNA BASIC

REVERSIBLE Y COMBINABLE
CON TODAS LAS COLECCIONES

COLUMNA BASIC SUSPENDIDA

| | |
|----------------|-------|
| ● Valenti | 73822 |
| ● Aliso | 73823 |
| ● Crudo | 73824 |
| ● Canela | 73825 |
| ● Abedul | 73826 |
| ○ B-ada | 73827 |
| ● Ceniza | 73828 |
| ● Avio | 73829 |
| ● Musgo | 73830 |
| ● Cotton | 73831 |
| ● Griggio | 73832 |
| ● Quzarzo | 73833 |
| ● Navy | 73834 |
| ● Black | 73835 |
| ○ Nieve Br. | 73837 |
| ● Gris Osc Br. | 73838 |
| ● Tórtora Br. | 73839 |

P. 216

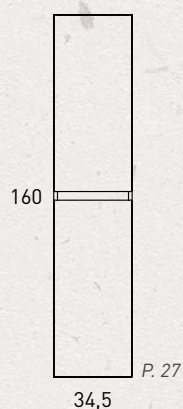

PATAS COMPATIBLES

| | |
|-----------------------|-------|
| ■ Box cromo (x4) | 73840 |
| ■ Granada alu (x4) | 73477 |
| ■ Granada black (x4) | 73478 |
| ■ Granada blanco (x4) | 73479 |





P. 13



Para opción a suelo, especificar código de las patas.

ARMARIO ESPEJO MIRANDA

ACABADOS EN SINTONÍA CON TU MUEBLE BAÑO

| Alto 63cm Prof 16cm |  60 2P |  80 2P |  100 3P |  120 3P |
|------------------------|---|---|--|--|
| ○ b-ada | 71973 | 71989 | 72005 | 72021 |
| ● cotton | 73454 | 73455 | 73456 | 73457 |
| ● ceniza | 71974 | 71990 | 72006 | 72022 |
| ● avio | 71975 | 71991 | 72007 | 72023 |
| ● musgo | 71976 | 71992 | 72008 | 72024 |
| ● cuarzo | 71977 | 71993 | 72009 | 72025 |
| ● griggio | 71978 | 71994 | 72010 | 72026 |
| ● navy | 71979 | 71995 | 72011 | 72027 |
| ● black | 71980 | 71996 | 72012 | 72028 |
| ● abedul | 71981 | 71997 | 72013 | 72029 |
| ● crudo | 71982 | 71998 | 72014 | 72030 |
| ● aliso | 72336 | 72337 | 72338 | 72339 |
| ● canela | 71983 | 71999 | 72015 | 72031 |
| ● valenti | 71984 | 72000 | 72016 | 72032 |
| ● niágara | 71985 | 72001 | 72017 | 72033 |
| ● nieve br | 71986 | 72002 | 72018 | 72034 |
| ● gris osc br | 71987 | 72003 | 72019 | 72035 |
| ● tórtora br | 71988 | 72004 | 72020 | 72036 |
| | 211 | 222 | 278 | 302 |



*Complétalo con el aplique Miranda



Accesorio enchufe Miranda

Podrás instalarlo en el Camerino Miranda

| Ref. | PVP |
|-------|-----------|
| 74916 | 30 |

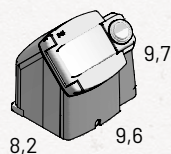

ESPEJOS

SEVILLA



| | | |
|------------|-------|-----------|
| 50 x 70cm | 72207 | 36 |
| 60 x 70cm | 80063 | 38 |
| 70 x 70cm | 85114 | 42 |
| 80 x 70cm | 80064 | 45 |
| 90 x 70cm | 83705 | 49 |
| 100 x 70cm | 80265 | 50 |
| 120 x 70cm | 80267 | 61 |

ELDA



| | | |
|------------|-------|------------|
| 60 x 70cm | 83016 | 62 |
| 70 x 70cm | 84586 | 69 |
| 80 x 70cm | 83017 | 78 |
| 100 x 70cm | 83018 | 90 |
| 120 x 70cm | 83019 | 106 |

PANDO



| | | |
|------------|-------|-----------|
| 60 x 70cm | 80221 | 43 |
| 80 x 70cm | 80223 | 51 |
| 100 x 70cm | 80225 | 61 |
| 120 x 70cm | 80226 | 66 |

LISS



| | | |
|---------|-------|-----------|
| 50 Ø cm | 72205 | 58 |
| 70 Ø cm | 85109 | 67 |
| 80 Ø cm | 70314 | 77 |
| 90 Ø cm | 87215 | 81 |

ADA



| | | |
|-----------|-------|-----------|
| 50 x 80cm | 89358 | 67 |
|-----------|-------|-----------|

LUNE



| | | |
|------------|-------|-----------|
| 50 x 120cm | 71970 | 79 |
|------------|-------|-----------|

LOIRA



| | | |
|----------------|-------|------------|
| ● 50x80 negro | 87650 | 96 |
| ○ 50x80 blanco | 87651 | 96 |
| ● 50x80 dorado | 73489 | 106 |

ALEXA



| | | |
|----------------|-------|------------|
| ● 70Øcm negro | 87647 | 99 |
| ○ 70Øcm blanco | 87646 | 99 |
| ● 70Øcm dorado | 73483 | 109 |
| ● 80Øcm negro | 73117 | 121 |
| ○ 80Øcm blanco | 73116 | 121 |
| ● 80Øcm dorado | 74917 | 133 |
| ● 90Øcm negro | 87649 | 125 |
| ○ 90Øcm blanco | 87648 | 125 |
| ● 90Øcm dorado | 73484 | 138 |

CAPRI



*Reversible

| | | |
|-----------------|-------|------------|
| ○ 60x80 b-ada | 87660 | 104 |
| ● 60x80 black | 87661 | 104 |
| ● 60x80 ceniza | 87662 | 104 |
| ● 60x80 avio | 87663 | 104 |
| ● 60x80 cotton | 87664 | 104 |
| ● 60x80 musgo | 87665 | 104 |
| ● 60x80 navy | 70315 | 104 |
| ● 60x80 griggio | 70316 | 104 |

NUEVO ESPEJO

VARIO



Touch



Temperatura regulable

VARIO REDONDO

| cm | Ref. | PVP |
|---------|-------|------------|
| 60 Ø cm | 73492 | 222 |
| 80 Ø cm | 73493 | 290 |

VARIO CUADRADO

| cm | Ref. | PVP |
|-------|-------|------------|
| 60x60 | 73494 | 235 |
| 80x80 | 73495 | 319 |



Luz cálida



Luz fría

Regula la temperatura de luz pulsando el botón touch.



3000k

Temperatura regulable

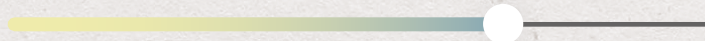

6000k

ESPEJOS LED



LUMEN

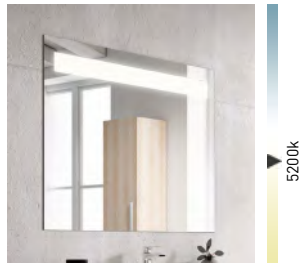

| cm | Ref. | PVP |
|----------|-------|------------|
| 60x70cm | 82219 | 140 |
| 80x70cm | 82220 | 170 |
| 100x70cm | 82221 | 201 |
| 120x70cm | 82222 | 248 |

LIGHT

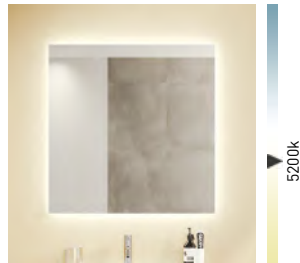

| cm | Ref. | PVP |
|----------|-------|------------|
| 60x70cm | 82548 | 173 |
| 80x70cm | 82549 | 186 |
| 100x70cm | 82550 | 206 |
| 120x70cm | 82551 | 221 |

FRAME

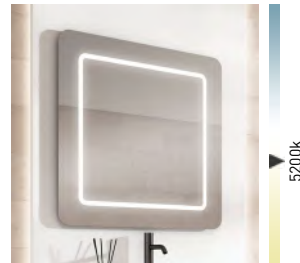

| cm | Ref. | PVP |
|----------|-------|------------|
| 60x80cm | 80208 | 213 |
| 80x80cm | 80209 | 239 |
| 100x80cm | 80222 | 249 |

LISS

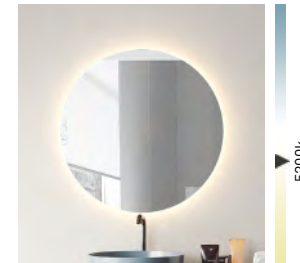

| cm | Ref. | PVP |
|---------|-------|------------|
| 50 ∅ cm | 72206 | 144 |
| 70 ∅ cm | 87408 | 170 |
| 80 ∅ cm | 87769 | 189 |
| 90 ∅ cm | 87407 | 216 |

BLUE

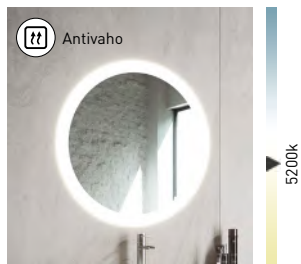

| cm | Ref. | PVP |
|---------|-------|------------|
| 70 ∅ cm | 84282 | 238 |

CLOE

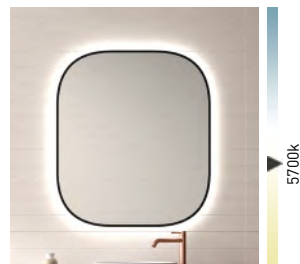

| cm | Ref. | PVP |
|---------|-------|------------|
| 60x70cm | 70082 | 228 |
| 80x70cm | 70083 | 268 |

PARIS

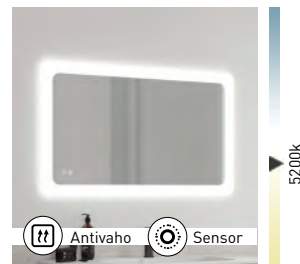

| cm | Ref. | PVP |
|----------|-------|------------|
| 60x60cm | 88942 | 279 |
| 80x60cm | 88943 | 292 |
| 100x60cm | 88944 | 312 |

ALEXA

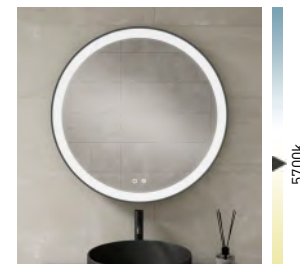

| cm | Ref. | PVP |
|-----------|-------|------------|
| ● 70 ∅ cm | 87681 | 215 |
| ○ 70 ∅ cm | 87680 | 215 |
| ● 70 ∅ cm | 73485 | 225 |
| ● 80 ∅ cm | 73121 | 266 |
| ○ 80 ∅ cm | 73120 | 266 |
| ● 80 ∅ cm | 74919 | 278 |
| ● 90 ∅ cm | 87683 | 281 |
| ○ 90 ∅ cm | 87682 | 281 |
| ● 90 ∅ cm | 73487 | 294 |

ADA

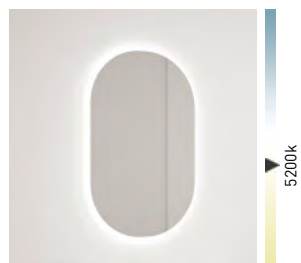

| cm | Ref. | PVP |
|---------|-------|------------|
| 50x80cm | 87218 | 177 |

SOUL

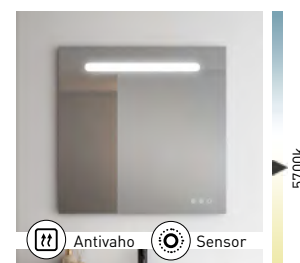

| cm | Ref. | PVP |
|----------|-------|------------|
| 60x80cm | 70084 | 278 |
| 80x80cm | 70085 | 326 |
| 100x80cm | 70086 | 370 |
| 120x80cm | 70087 | 406 |

LOIRA

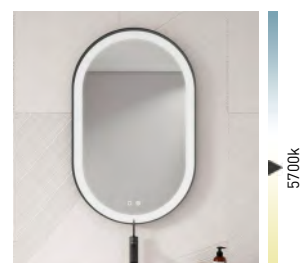

| | Ref. | PVP |
|-------------------|-------|------------|
| ● 50x80cm | 87666 | 222 |
| ○ 50x80cm | 87667 | 222 |
| ● 50x80cm | 73490 | 232 |
| Sensor & Antivaho | | |
| ● 50x80cm | 87672 | 282 |
| ○ 50x80cm | 87673 | 282 |
| ● 50x80cm | 73491 | 292 |

LUNE

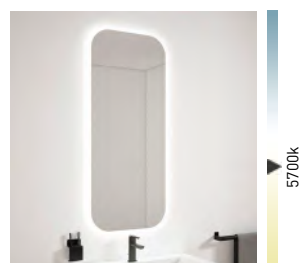

| cm | Ref. | PVP |
|----------|-------|------------|
| 50x120cm | 71971 | 203 |

| Sensor & Antivaho | | |
|-------------------|-------|------------|
| 50x120cm | 71972 | 272 |

APLIQUES / ACCESORIOS

ARYA

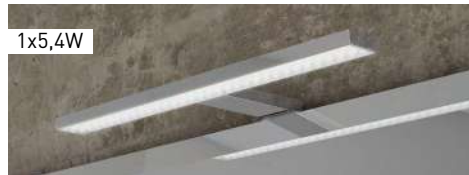

30 x 15 x 2,5 cm **Ref. 83446** **PVP 34**

FUNNY



23,5 x 8,5 x 4 cm **Ref. 83445** **PVP 28**

OPORTO

*Compatible con espejo Elda



| | Pot. | Cromo | Negro | PVP |
|--------|------|-------|-------|------------|
| 60 cm | 15W | 87652 | 87656 | 71 |
| 80 cm | 20W | 87653 | 87657 | 89 |
| 100 cm | 25W | 87654 | 87658 | 114 |
| 120 cm | 30W | 87655 | 87659 | 133 |

NOVA



30 x 8 x 2,5 cm **Ref. 84040** **PVP 50**
 30 x 8 x 2,5 cm **Ref. 84041** **PVP 50**

GLOW

*Compatible con espejo Liss y Ada



Glow 90 cm cromo **Ref. 71049** **PVP 44**
 Glow 90 cm negro **Ref. 71194** **PVP 44**

MIRANDA

*Compatible con camerino Miranda

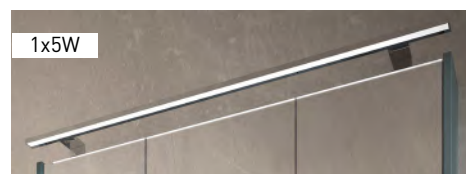

60 cm **Ref. 73590** **PVP 68**
 80 cm **Ref. 73591** **PVP 85**
 100cm **Ref. 73592** **PVP 96**

SOPORTE EASY



| | Secador | Plancha |
|---------------|-----------|-----------|
| Blanco | 88964 | 88967 |
| Cromo | 88962 | 88965 |
| Negro | 88963 | 88966 |
| PVP | 41 | 41 |

*Instalación sin taladro.
 No necesita elementos de fijación.

TOALLERO EASY



| | Ref. |
|---------------|-----------|
| Blanco | 88961 |
| Cromo | 88959 |
| Negro | 88960 |
| PVP | 41 |

*Instalación sin taladro.
 No necesita elementos de fijación. Max. 5kg

ESTRUCTURA / PATAS



| | Ref. |
|---------------|-----------|
| Blanco | 88973 |
| Negro | 88972 |
| PVP | 66 |

*El mueble debe ser fijado a la pared.
 Herraje de fijación incluidos.

VALVULA UNIVERSAL



| | Ref. | PVP |
|--------------|-------|-----------|
| Cromo | 85112 | 20 |
| Negro | 85113 | 30 |

ORGANIZADOR

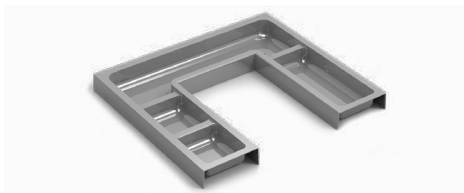

| | Ref. | PVP |
|--------------|-------|-----------|
| 280x120x10mm | 82576 | 27 |

*Compatible con/Suitable for:
 Arco, Box, Granada, Kyoto, Bondi, Scala,
 Vision, Eleven, Indico y Aqua.

*No compatible con/Not suitable for:
 Box de fondo reducido

PRODUCTOS EXPRESS / CONDICIONES

Se consideran productos con servicio Express aquellos que aparecen en este folleto, sólo en las medidas y combinaciones señaladas en **Rosa**.

Los productos y precios Promobath son sólo los que aparecen en este folleto. Para cualquier otra combinación o acabado, ver Catálogo General.

Servicio Express:

- . Recepción del pedido antes de la 13:00h: **servicio 48-72h.**
- . Recepción del pedido después de la 13:00h: **servicio 72-96h.**

- . Consultar servicio para las Islas Baleares, Canarias y Portugal.

Condiciones generales:

- . El cliente está obligado a revisar toda la mercancía una vez llega a sus instalaciones. En caso de detección de cualquier tipo de daño (aparente o no), o defectos de cantidad o calidad, el cliente deberá notificarlo vía correo electrónico a la empresa Visobath en un plazo máximo de 24h.
- . La garantía Visobath no cubre defectos o fallos causados por el instalador, usuario o cualquier otra persona en su manipulación.
- . Servicio contra stock sujeto a disponibilidad.
- . IVA no incluido en los precios.
- . No se aplicarán descuentos adicionales sobre los precios indicados en este folleto.
- . Los colores representados en este folleto pueden sufrir, debido a las técnicas de impresión, ligeras variaciones de tono respecto al material original.



Instalación muebles



Biobacter® - Kupsa
Lacado antibacterias



Venta y distribución
del mueble de baño



14-35-00215-CUC



C170186



VISOBATH

DESCUBRE CATÁLOGO TRENDS & GLOBAL 5

